

# MUJIE 慕杰<sup>®</sup>

YOUR AUTOMATION, YOUR MUJIE!

结构简单，性能可靠，设计灵活，方便安装  
适用于位移，转角，应变，压力，  
振动等多种物理量的测量

## M3 M4反射型光纤传感器 M3 M4 reflective optical fiber sensor

Simple structure, reliable performance, flexible design  
and convenient installation. Applicable to displacement,  
angle, strain, pressure, Measurement of vibration and  
other physical quantities



型号 Model	MFS-D110
检测距离 Detection distance	20/60/150mm
最小弯曲半径 Minimum bending radius	R25
耐温 Temperature resistance	-40至+70°C

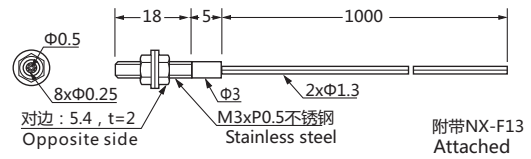

型号 Model	MFS-D186
检测距离 Detection distance	30/60/150mm
最小弯曲半径 Minimum bending radius	R25
耐温 Temperature resistance	-40至+70°C

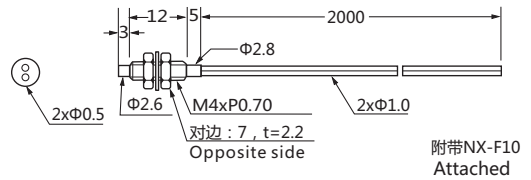

型号 Model	MFS-D184
检测距离 Detection distance	30/60/150mm
最小弯曲半径 Minimum bending radius	R25
耐温 Temperature resistance	-40至+70°C

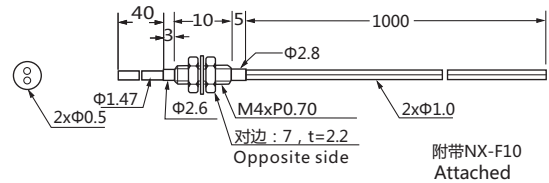

型号 Model	MFS-D093
检测距离 Detection distance	30/120/180mm
最小弯曲半径 Minimum bending radius	R25
耐温 Temperature resistance	-40至+70°C

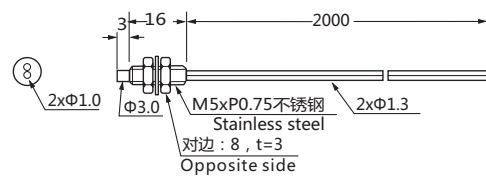

型号 Model	MFS-D094
检测距离 Detection distance	30/60/100mm
最小弯曲半径 Minimum bending radius	R10
耐温 Temperature resistance	-40至+70°C

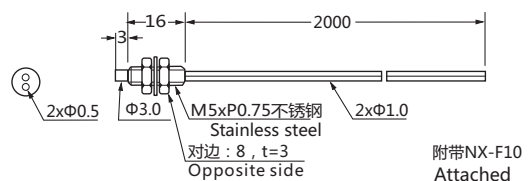

编码器/磁栅尺  
Encoder/Magnetic Scale

位移/倾角/计数器  
Displacement/Inclination/Counter

接近/加速度/温度  
Proximity/Acceleration/Temperature

光电/超声波/区域  
Photoelectric/Ultrasonic/Area

压力/称重  
Pressure / load cell

联轴器/附件  
Couplings/Accessories

# MUJIE 慕杰®

YOUR AUTOMATION, YOUR MUJIE!

结构简单，性能可靠，设计灵活，方便安装  
适用于位移，转角，应变，压力，  
振动等多种物理量的测量

## M6漫反射光纤传感器系列

M6 opposed optical fiber MFS sensor

Simple structure, reliable performance, flexible design  
and convenient installation. Applicable to displacement,  
angle, strain, pressure, Measurement of vibration and  
other physical quantities



型号 Model	MFS-D159
检测距离 Detection distance	60/150/300mm
最小弯曲半径 Minimum bending radius	R25
耐温 Temperature resistance	-55至+70°C

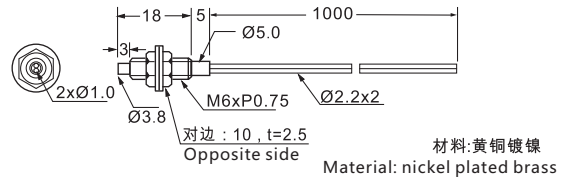

型号 Model	MFS-D161
检测距离 Detection distance	60/150/300mm
最小弯曲半径 Minimum bending radius	R25
耐温 Temperature resistance	-55至+70°C

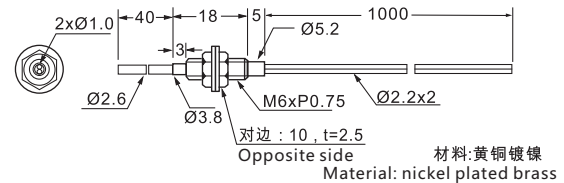

型号 Model	MFS-D075
检测距离 Detection distance	15/30/45mm
最小弯曲半径 Minimum bending radius	R2(R1)
耐温 Temperature resistance	-40至+70°C

\* 带R表示耐弯折光纤,最小弯曲半径为 R1。  
The band R represents bending resistant optical fiber, and the minimum bending radius is R1.

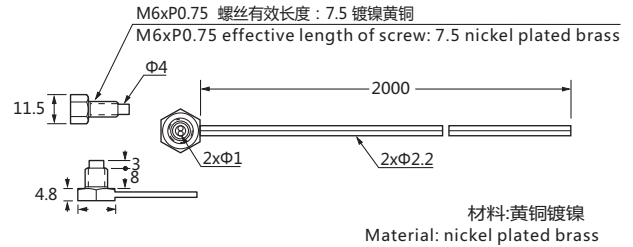

型号 Model	MFS-D076
检测距离 Detection distance	60/150/280mm
最小弯曲半径 Minimum bending radius	R25
耐温 Temperature resistance	-40至+70°C

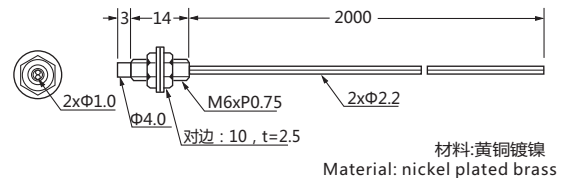

型号 Model	MFS-D080
检测距离 Detection distance	60/120/150mm
最小弯曲半径 Minimum bending radius	R22
耐温 Temperature resistance	-40至+70°C

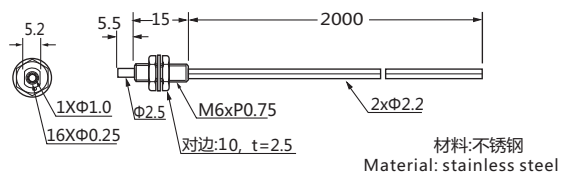

编码器/磁栅尺  
Encoder/Magnetic Scale

位移/倾角/计数器  
Displacement/Inclination/Counter

接近/加速度/温度  
Proximity/Acceleration/Temperature

光电/超声波/区域  
Photoelectric/Ultrasonic/Area

压力/称重  
Pressure / load cell

联轴器/附件  
Couplings/Accessories



## M3对射型光纤传感器

M3 opposed optical fiber sensor

Simple structure, reliable performance, flexible design  
and convenient installation. Applicable to displacement,  
angle, strain, pressure, Measurement of vibration and  
other physical quantities



型号 Model	MDS-T140
检测距离 Detection distance	140/500/1200mm
最小弯曲半径 Minimum bending radius	R25
耐温 Temperature resistance	-40至+70°C

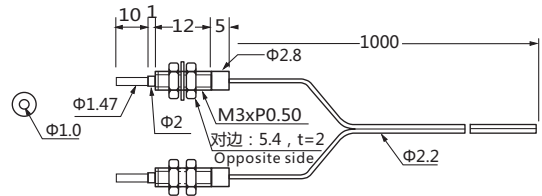

型号 Model	MDS-T141
检测距离 Detection distance	140/500/1200mm
最小弯曲半径 Minimum bending radius	R25
耐温 Temperature resistance	-40至+70°C

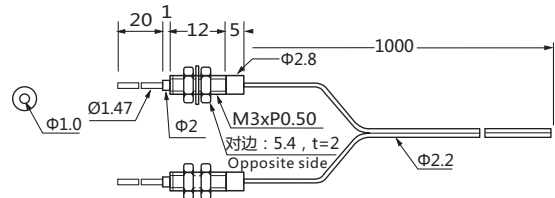

型号 Model	MDS-T142
检测距离 Detection distance	140/500/1200mm
最小弯曲半径 Minimum bending radius	R25
耐温 Temperature resistance	-40至+70°C

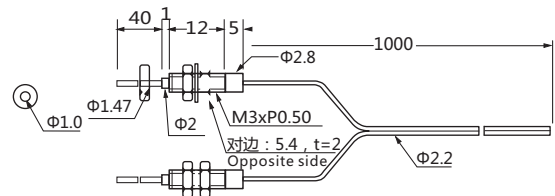

型号 Model	MDS-T143
检测距离 Detection distance	140/500/1200mm
最小弯曲半径 Minimum bending radius	R25
耐温 Temperature resistance	-40至+70°C

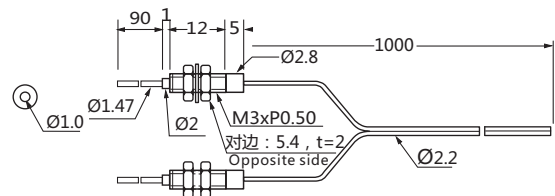

型号 Model	MDS-T144
检测距离 Detection distance	140/500/1200mm
最小弯曲半径 Minimum bending radius	R25
耐温 Temperature resistance	-40至+70°C

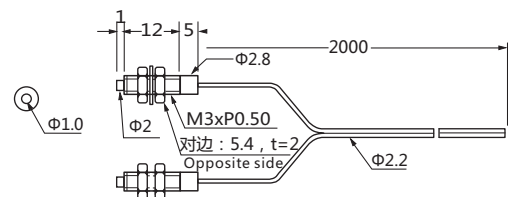

# MUJIE 慕杰®

YOUR AUTOMATION, YOUR MUJIE!

结构简单，性能可靠，设计灵活，方便安装  
适用于位移，转角，应变，压力，  
振动等多种物理量的测量



## M4、M6对射型光纤传感器 M4、M6 opposed optical fiber sensor

Simple structure, reliable performance, flexible design  
and convenient installation. Applicable to displacement,  
angle, strain, pressure, Measurement of vibration and  
other physical quantities



型号 Model	MDS-T064
检测距离 Detection distance	300/800/1500mm
最小弯曲半径 Minimum bending radius	R25
耐温 Temperature resistance	-40至+70°C

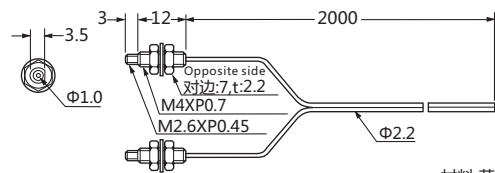

材料:黄铜镀镍  
Material: nickel plated brass



型号 Model	MDS-T068(R)
检测距离 Detection distance	150/500/1200mm
最小弯曲半径 Minimum bending radius	R2(R1)
耐温 Temperature resistance	-40至+70°C

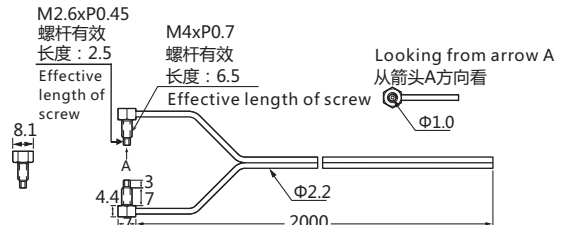

材料:镀镍黄铜  
Material: nickel plated brass

\* 带R表示耐弯折光纤,最小弯曲半径为 R1。  
The band R represents bending resistant optical fiber, and the minimum bending radius is R1.



型号 Model	MDS-T120
检测距离 Detection distance	140/500/1200mm
最小弯曲半径 Minimum bending radius	R25
耐温 Temperature resistance	-40至+70°C

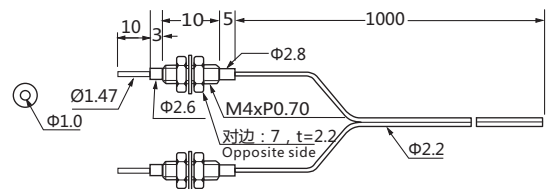

型号 Model	MDS-T129
检测距离 Detection distance	140/500/1200mm
最小弯曲半径 Minimum bending radius	R25
耐温 Temperature resistance	-40至+70°C

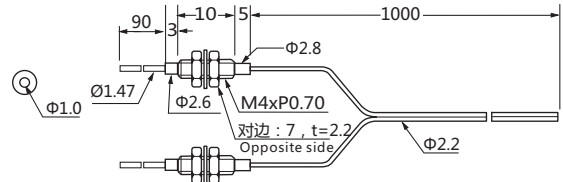

型号 Model	MDS-T059
检测距离 Detection distance	140/180/1200mm
最小弯曲半径 Minimum bending radius	R25
耐温 Temperature resistance	-40至+70°C

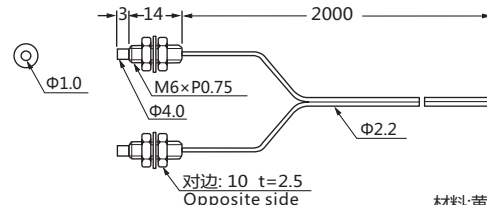

材料:黄铜镀镍  
Material: nickel plated brass

编码器/磁栅尺  
Encoder/Magnetic Scale

位移/倾角/计数器  
Displacement /Inclination /Counter

接近/加速度/温度  
Proximity /Acceleration /Temperature

光电/超声波/区域  
Photoelectric /Ultrasonic /Area

压力/称重  
Pressure / load cell

联轴器/附件  
Couplings/Accessories

# MUJIE 慕杰®

YOUR AUTOMATION, YOUR MUJIE!

结构简单，性能可靠，设计灵活，方便安装  
适用于位移，转角，应变，压力，  
振动等多种物理量的测量



## 矩阵型光纤传感器MJZ系列 Matrix optical fiber sensor MJZ series

Simple structure, reliable performance, flexible design  
and convenient installation. Applicable to displacement,  
angle, strain, pressure, Measurement of vibration and  
other physical quantities



MJZ-T024

推荐

型号 Model	MJZ-T024
检测距离 Detection distance	40/90/250mm
最小弯曲半径 Minimum bending radius	R2(R1)
耐温 Temperature resistance	-40至+70°C

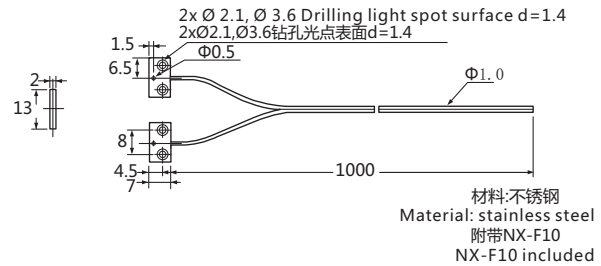

MJZ-T019

型号 Model	MJZ-T019
检测距离 Detection distance	40/100/200mm
最小弯曲半径 Minimum bending radius	R4 <sup>*2</sup>
耐温 Temperature resistance	-40至+70°C

\*带R表示耐弯折光纤, 最小弯曲半径为 R1.

The band R represents bending resistant optical fiber, and the minimum bending radius is R1.

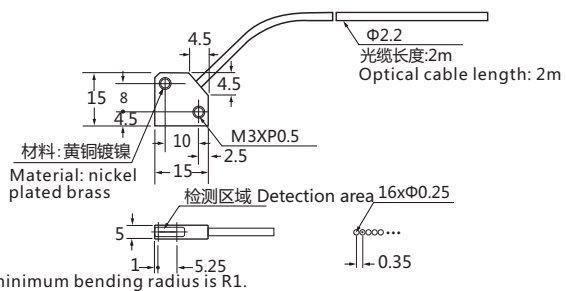

MJZ-T027

型号 Model	MJZ-T027
检测距离 Detection distance	35/100/320mm
最小弯曲半径 Minimum bending radius	R4
耐温 Temperature resistance	-40至+70°C

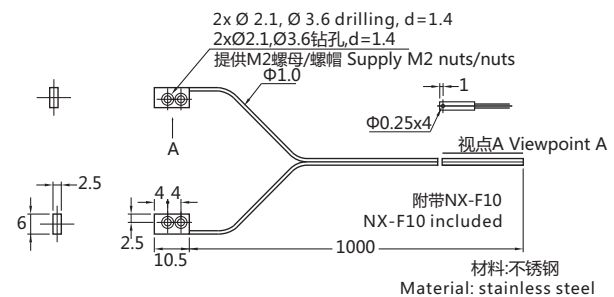

MJZ-T028

型号 Model	MJZ-T028
检测距离 Detection distance	45/130/380mm
最小弯曲半径 Minimum bending radius	R2
耐温 Temperature resistance	-40至+70°C

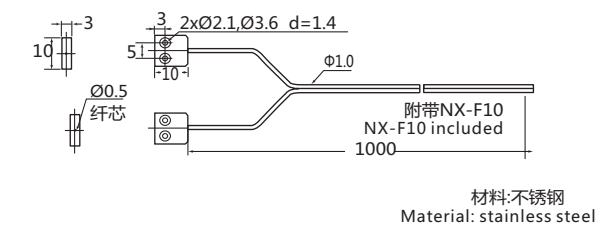

MJZ-T021

型号 Model	MJZ-T021
检测距离 Detection distance	160/350/600mm
最小弯曲半径 Minimum bending radius	R25
耐温 Temperature resistance	-40至+70°C

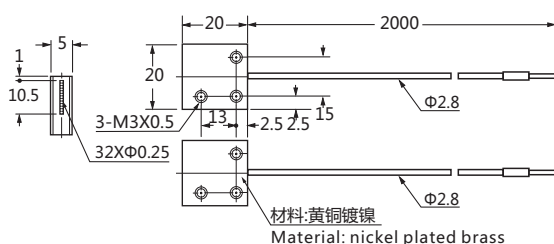

编码器/磁栅尺  
Encoder/Magnetic Scale

位移/倾角/计数器  
Displacement / Inclination / Counter

接近/加速度/温度  
Proximity / Acceleration / Temperature

光电/超声波/区域  
Photoelectric / Ultrasonic / Area

压力/称重  
Pressure / Load cell

联轴器/附件  
Couplings/Accessories

# MUJIE 慕杰®

YOUR AUTOMATION, YOUR MUJIE!

结构简单，性能可靠，设计灵活，方便安装  
适用于位移，转角，应变，压力，  
振动等多种物理量的测量

## 矩列型光纤传感器MJZ系列

Rectangular optical fiber sensor MJZ series other physical quantities

Simple structure, reliable performance, flexible design  
and convenient installation. Applicable to displacement,  
angle, strain, pressure, Measurement of vibration and



MJZ-T30



型号 Model	MJZ-T30
检测距离 Detection distance	700/1200/2000mm
最小弯曲半径 Minimum bending radius	R2
耐温 Temperature resistance	-40至+70°C

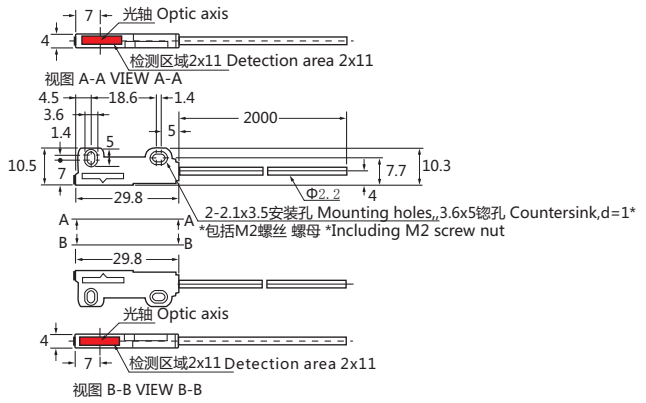

MJZ-T69



型号 Model	MJZ-T69
检测距离 Detection distance	1200/1800/2200mm
最小弯曲半径 Minimum bending radius	R2
耐温 Temperature resistance	-40至+70°C

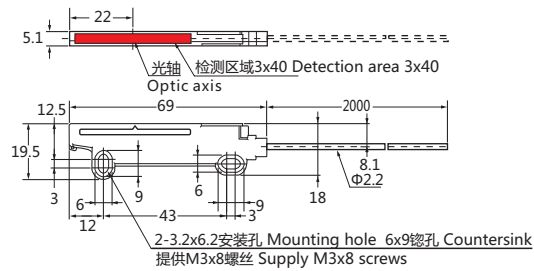

MJZ-T60



型号 Model	MJZ-T60
检测距离 Detection distance	180/400/800mm
最小弯曲半径 Minimum bending radius	R25
耐温 Temperature resistance	-40至+70°C

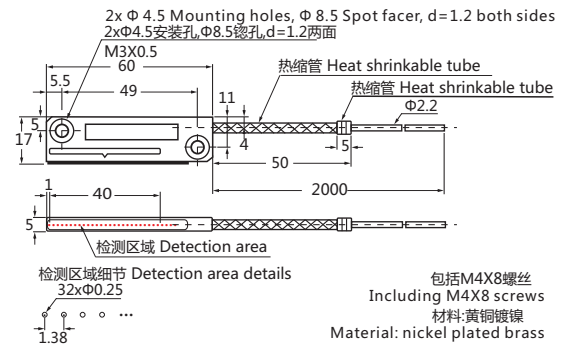

MJZ-T120



型号 Model	MJZ-T120
检测距离 Detection distance	160/450/650mm
最小弯曲半径 Minimum bending radius	R25
耐温 Temperature resistance	-40至+70°C

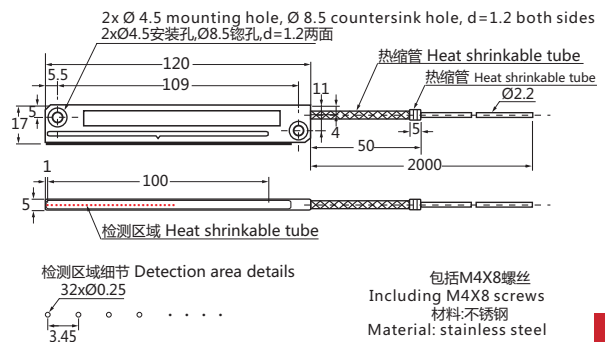

编码器/磁栅尺  
Encoder/Magnetic Scale

位移/倾角/计数器  
Displacement /Inclination /Counter

接近/加速度/温度  
Proximity/Acceleration/Temperature

光电/超声波/区域  
Photoelectric/Ultrasonic/Area

压力/称重  
Pressure / load cell

联轴器/附件  
Couplings/Accessories